

FISHMAC S.R.L.

Packaging machines and conveyor solutions

Dividers

Automatic sealing machine

Packs conveyor

Bottling lines

Bottles conveyor

Bottle elevator / lowerator

Decompression tables

Air conveyor

Pallets conveyor

Reformed Overturner

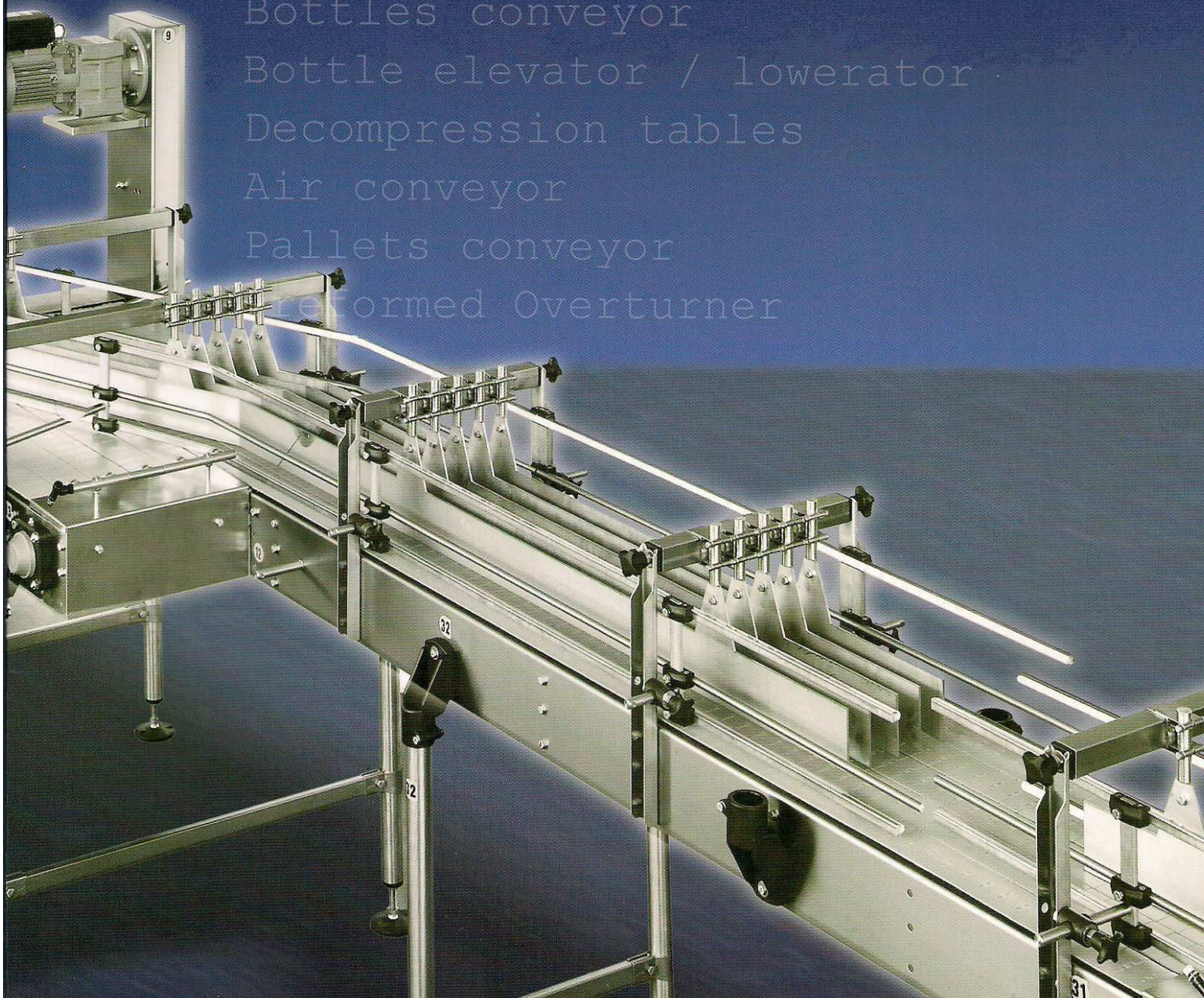

Trasporti bottiglie - Bottles conveyor



Trasporti bottiglie con curve
Curve carton conveyors



Trasporto bottiglie con spondina mobile
Bottle conveyor with moving side

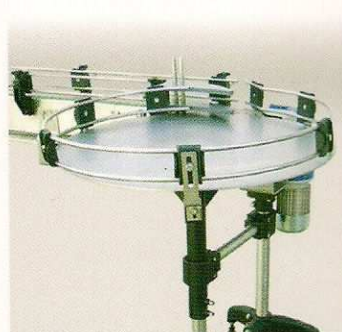

Piano di raccolta prodotto
Product collect plate



It Tecnopak è specializzata nella produzione di trasportatori per ogni tipo di prodotto. Costruiti in acciaio inox 304 (salvo diverse richieste da parte del cliente), sono completi di spondine regolabili in base al prodotto da movimentare. La modularità e la standardizzazione degli elementi consente un'installazione rapida ed una manutenzione semplice e veloce.

En Tecnopak is specialized in the manufacture of conveyors for any kind of product. Built in stainless steel AISI 304 (except when differently request by customer), they are complete with lateral side guides that can be adjusted according to the product to be moved. The modularity and standardization of the elements permit a quick installation and a simple and rapid maintenance.

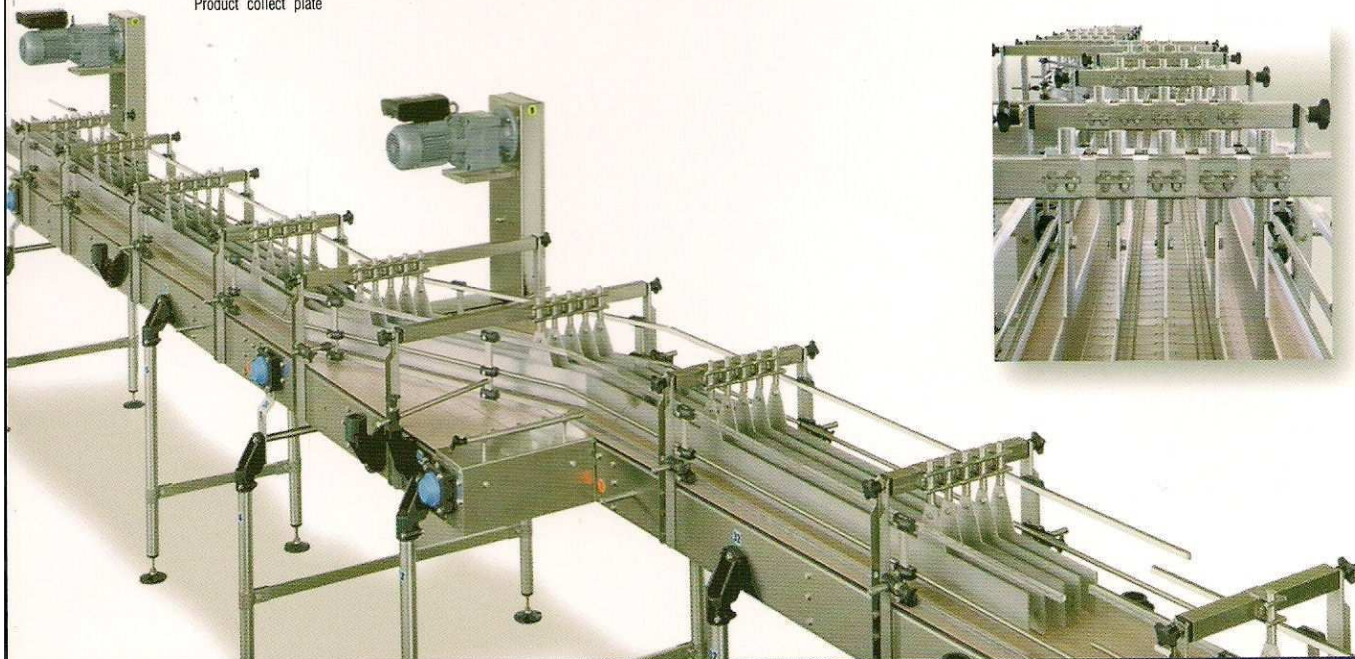
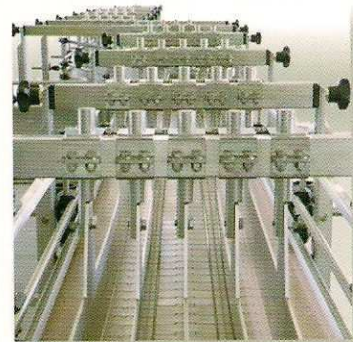

Linea completa - Complete line

① =DEPALETTIZZATORE
=DEPALLETIZER

② =SOFFIATRICE
=PET BLOW MOULDING MACHINE

③ =TRASPORTI BOTTIGLIE
=BOTTLE CONVEYORS

④ =TRIBLOCCO= SCIAQUATRICE-RIEMPITRICE-TAPPATORE
=TRIBLOCK=RINSER-FILLER-CAPPER

⑤ =CAPSULATRICE
=CAPPING MACHINE

⑥ =ETICHETTATRICE
=LABELLING MACHINE

⑦ =FORMACARTONI
=CARTON SQUARING MACHINE

⑧ =INCARTONATRICE
=CARTON FILLING MACHINE

⑨ =INCOLLATORE
=GLUING MACHINE

⑩ =TRASPORTO CARTONI
=CARTON CONVEYORS

⑪ =DISCESORE CARTONI
=CARTON LOWERING DEVICE

⑫ =PALETTIZZATORE
=PALLETIZER

⑬ =AVVOLGIBANCALE
=STRETCH WRAPPER

PIANO SUPERIORE
TOP LANE

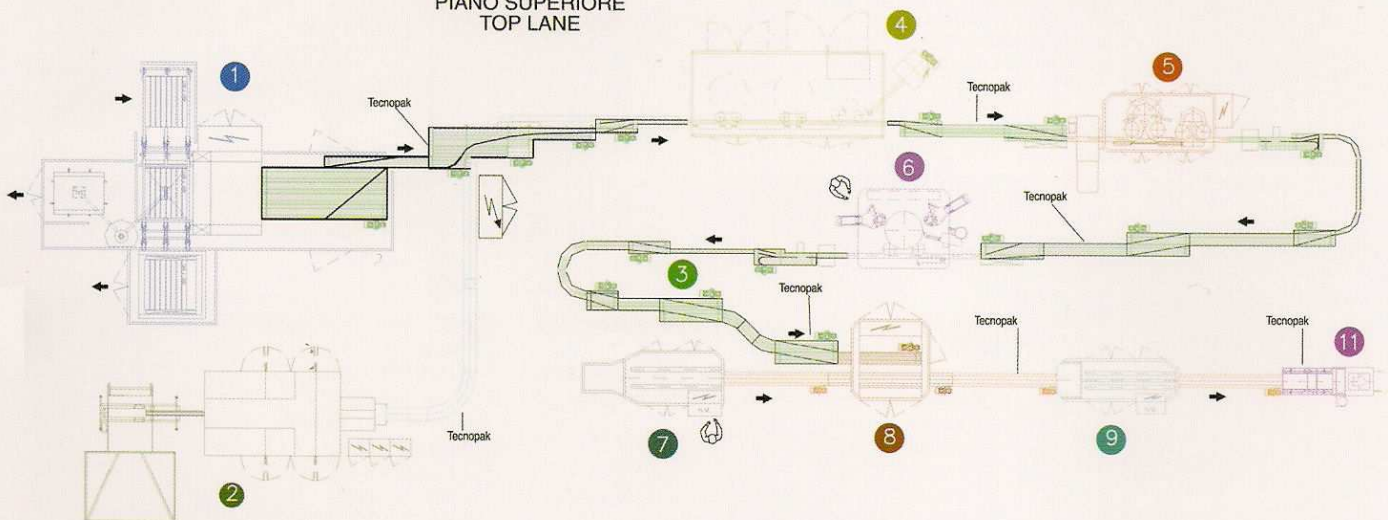

It Tecnopak ha la capacità e l'esperienza, maturate negli anni, di progettare e costruire linee complete offrendo ai propri clienti un servizio completo dal progetto di fattibilità alla costruzione ed al collaudo finale.

Tecnopak da anni garantisce, grazie ai propri prodotti, un ottimo supporto a tutti i costruttori di linee complete.

En Tecnopak has the capability and experience, completed in years, to project and manufacture complete lines; it offers to its own customers a complete service starting from the feasibility of project to the construction and the final test.

Tecnopak assures, an optimum support to all manufacturers of complete lines, thanks to its own products.

PIANO INFERIORE
BOTTOM PLANE

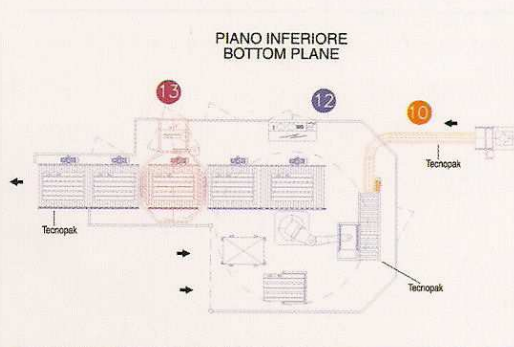

VISTA LATERALE DISCESORE CARTONE
CARTON LOWERING DEVICE SIDE SIGHT

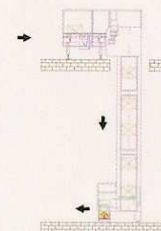

Nastratrice automatica / Automatic sealing machine



It Nastratrice automatica "Nastropak"
La macchina, costruita interamente in acciaio inox 304, è idonea alla chiusura con nastro in PVC largo 50 mm delle falde superiori e inferiori di cartoni tipo americano. La nastratrice è completa di:

- quadro elettrico per comando motori e gestione fotocellula;
- impianto pneumatico per gestione testata nastrante;
- due nastri laterali per trazione del cartone;
- testa nastrante per PVC da 50 mm;
- protezioni antinfortunistiche con porte protette da micro;
- volantini di registrazione per cambio formato manuale.

En Nastratrice automatica "Nastropak"
The machine, built in stainless steel, is suitable for closure with tape of upper and bottom sides of carton boxes.

Nastropak is complete with:

- control panel for engines and photocell;
- pneumatic plant for taping head management;
- two conveyors for lateral box dragging;
- taping head for tape width 50 mm;
- safety protections with microswitch on each door;
- wheels for manual format change.

Trasporto cartoni, fardelli, casse - Conveyor cartons, packs, crates

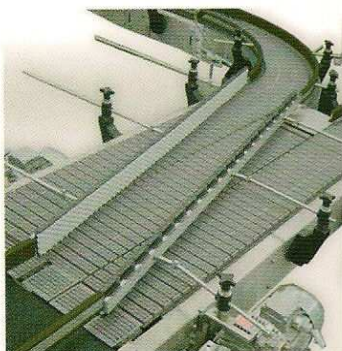

Trasporto fardelli con deviazione da due linee ad una linea
Pack conveyor with change from two line to one line

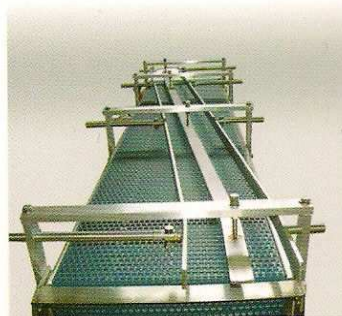

Trasporto motorizzato per vaschette plastica
Powered conveyor for plastic jars

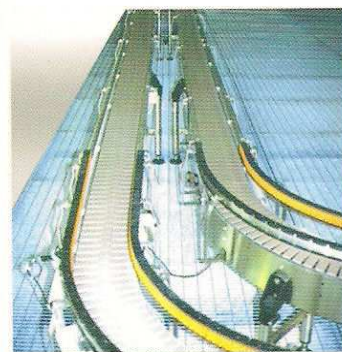

Trasporti cartone
Carton conveyors



Trasporto a tappeto con gira-pacchi
Carpet conveyor with pack turning device



trasportatore con catena a rullini frizionati per accumulo
senza pressione
Chain conveyor with fractioned rollers for accumulation
without pressure



It Trasportatori con struttura in acciaio inox AISI 304.

Costruiti in base alle caratteristiche del prodotto da movimentare e alle dimensioni richieste dal cliente.

Tecnopak produce:

- Trasporti a rulli;
- Trasporti a catena in plastica o inox;
- Tappeti vibranti;
- Tappeti di risalita;
- Trasporti con catena a tappeto;
- Costruzione di trasporti su richiesta del cliente.

En Conveyors with stainless steel AISI 304 structure.

They are built according to characteristic of product and to dimensions required by customer.

Tecnopak manufactures:

- Roller conveyors;
- Chain conveyors in plastic or stainless steel
- Roller conveyor;
- Chain conveyor in plastic or stainless steel;
- Vibrating carpet;
- Lifting carpets;
- Carpet chain conveyor;
- Manufacture of conveyors on customer's requests.

Incrocio motorizzato
Powered crossing conveyor



Rulliere motorizzate
Powered roller conveyor



Trasporti alla rinfusa - Bulk conveyors

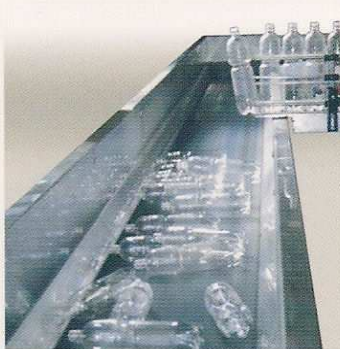
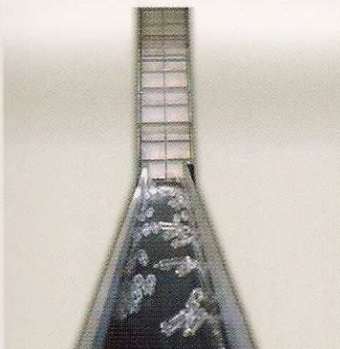

It Tecnopak è leader nella produzione di nastri trasportatori per bottiglie di ogni forma e materiale. Grazie ad un'esperienza pluriennale e ad un costante investimento nella ricerca e nello sviluppo, l'azienda ha acquistato un vasto mercato nel settore delle acque minerali, soft drink, cosmetica e detersivi. Tecnopak è sempre attenta nel dare continuità e coerenza al proprio operato, per garantire risposte adeguate alle esigenze di progettazione realizzazione ed assistenza, della propria clientela.

En Tecnopak is leader in the production of conveyor-belts for every kind of bottle. The company has gained in mineral water, soft drink, beauty culture, detergents trade-market, thanks to many years of experience and persevering investment into research and development. Tecnopak always is careful giving coherence and continuity to its products to assure good plans realizations and service to the client.

Divisore multi-file - Multi-lanes dividers

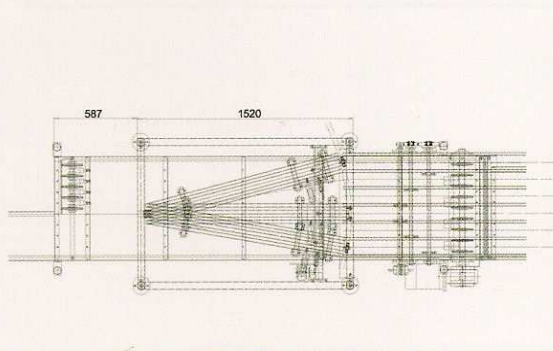

It Divisori multi-file, costruiti in base alle caratteristiche del prodotto da lavorare ed alle produzioni richieste.

En Multi-lanes dividers which are manufactured in conformity with the different features of the products to handle and the requested speed.

Trasporto pallet - Pallets conveyor



Trasporto pallet girevole
Turning pallet conveyor



Deviazione a 90° fra catene e rulli
90° deviation between chains and rollers



Trasporti pallets a rulli
Pallet roller conveyors

It Tecnopak progetta e costruisce nastri trasportatori in funzione della dimensione, tipo e peso del prodotto da movimentare; oltre a disporre di una vasta gamma di nastri trasportatori pallets di tipo "standard", ne garantiamo robustezza, affidabilità e costi.

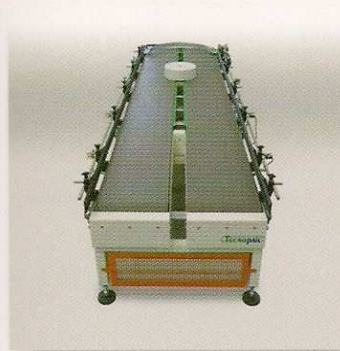

Trasporti a nastro, anche per settore alimentare
Conveyor belts, for foodstuff field

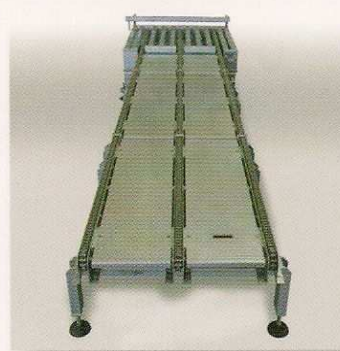

Trasporto pallet a catena
Pallet chain - conveyor



Magazzino pallet automatico
Automatic pallet storage

En Tecnopak projects and manufactures conveyors according to the dimensions, type and weight of product to be moved; other than a standard wide range of pallet conveyors assures sturdiness, reliability and minimum costs.

Elevatore / discensore - Bottle elevator / lowerator

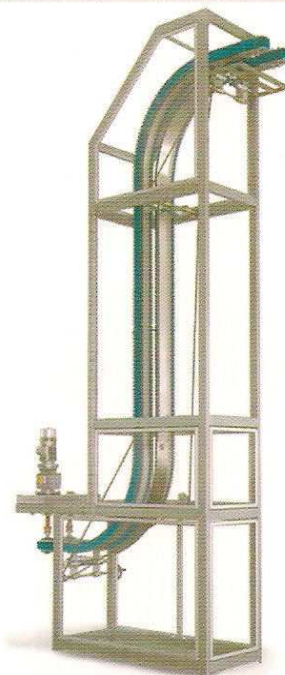
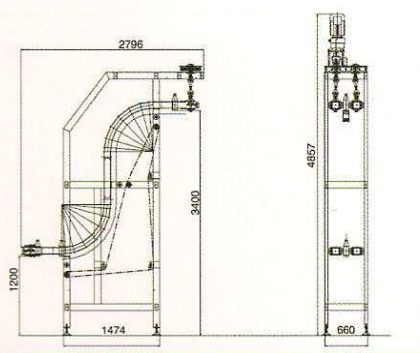
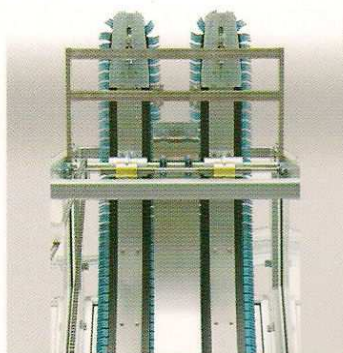

It Elevatore / discensore a "tampone" per bottiglie. Costruito con una robusta struttura adatto a trasportare le bottiglie a livelli superiori o inferiori. La velocità è variabile tramite motovariatore, completo di quadro elettrico e protezioni antinfortunistiche costruite a norme. Disponibile in varie versioni.

En Lifting / descending conveyor with "pad" for bottles. Built with strong structure, it is suitable to move the bottles to lower or upper levels. The speed can be changed by adjustable speed motor. It is complete with electric switchboard and safety-guards built according laws. It is available in different versions.

Elevatore / discensore a ripiani - Plane elevator/lowerator

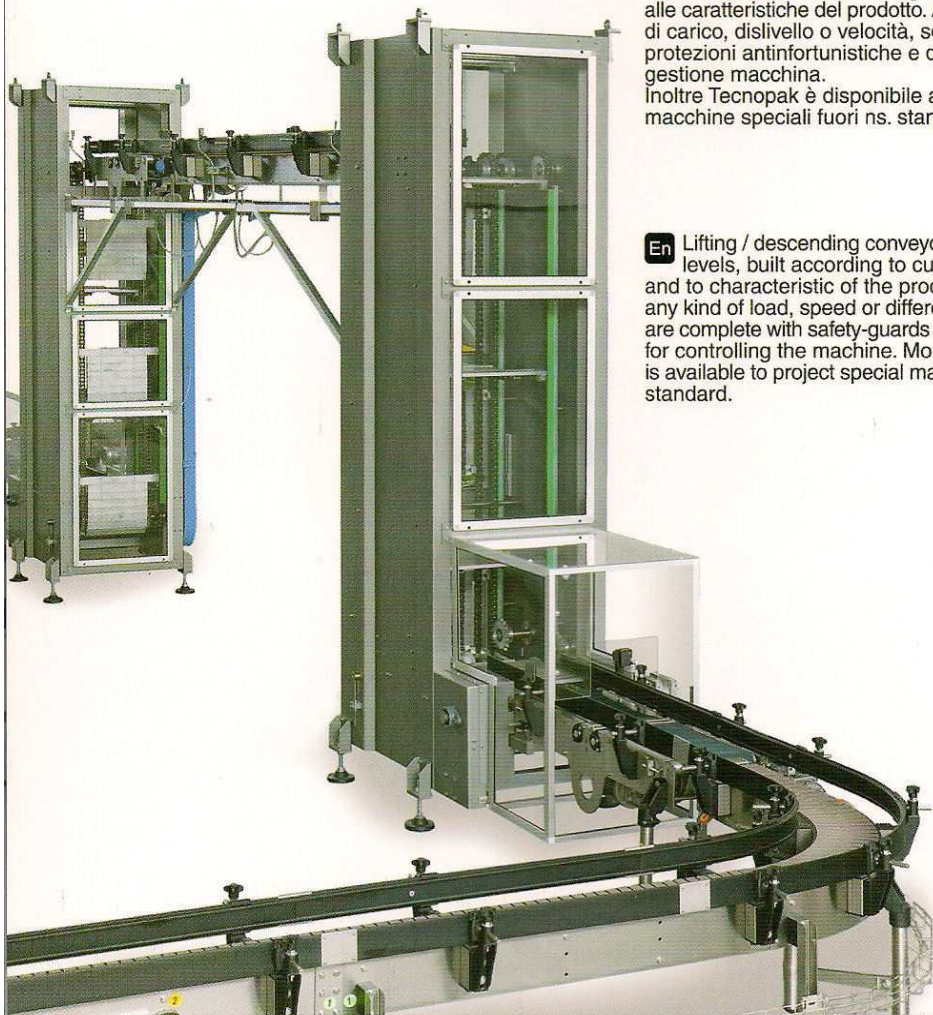

It Elevatore o discensore a ripiani continui, costruito in base alle esigenze del cliente e alle caratteristiche del prodotto. Adatti ad ogni tipo di carico, dislivello o velocità, sono completi di protezioni antinfortunistiche e quadro elettrico di gestione macchina. Inoltre Tecnopak è disponibile a progettare macchine speciali fuori ns. standard.

En Lifting / descending conveyor with continuous levels, built according to customer's needs and to characteristic of the product. Suitable for any kind of load, speed or difference of level, they are complete with safety-guards and electric board for controlling the machine. Moreover Tecnopak is available to project special machines, out of our standard.

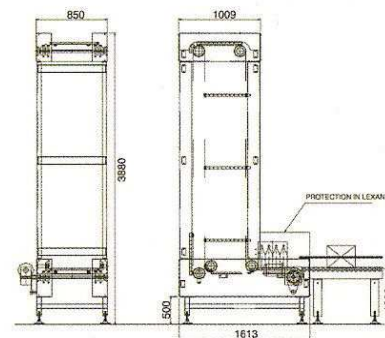

Trasporto ad aria - Air conveyor

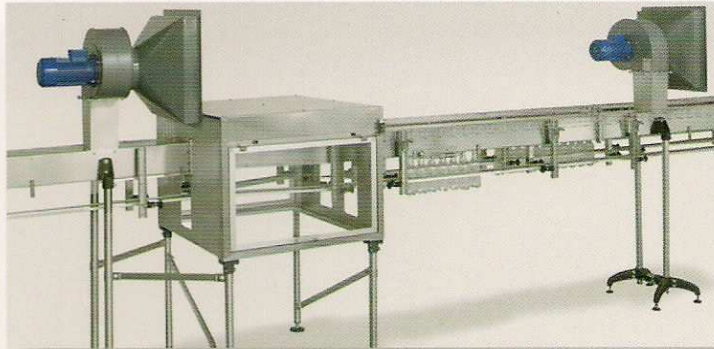
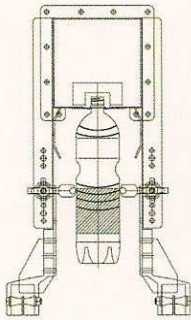

It Supportando le bottiglie per il collareto dell'imboccatura, il trasporto ad aria è adatto alla movimentazione di contenitori instabili quali bottiglie vuote in PET. Il movimento è dato da aria innessa nel canale di trasporto da un sistema di ventilatori centrifughi. La struttura è in acciaio inox ed utilizza componenti in materiale plastico anticorrosione.

En Air conveyor is suitable to carry unstable containers. For example, empty PET bottles, which are taken from the neck. The air is introduced in the transport tube by centrifugal ventilator system and all this causes the movement. The conveyor has an inox steel with anticorrosion plastic material structure.

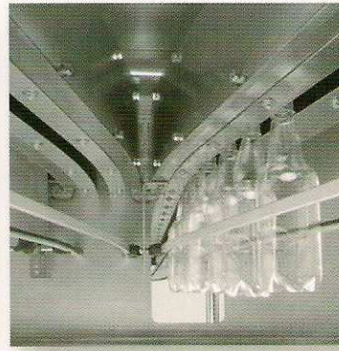
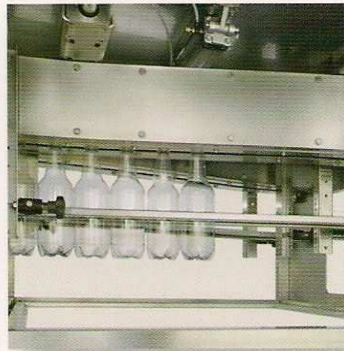
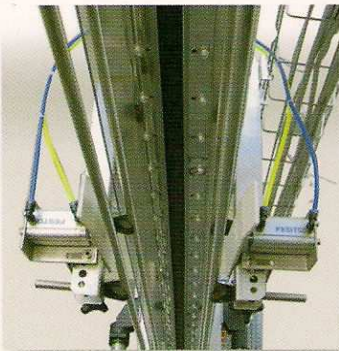

Ribaltatore per preforme - preformed overturner



It Di nuova progettazione, il ribaltatore preforme è costruito interamente in ferro verniciato e viene fornito completo di centralina idraulica, quadro elettrico e reti di protezione (a richiesta).

Sono disponibili 2 versioni:
a) con carico a muletto
b) con carico a transpales

En The preformed overturner is a new Tecnopak realization and it is constructed with coloured inox completely; it is provided with a hydraulics - station, electric panel and protection wire nettings (according to the client request).

There are two models of this overturner:
a) with trolley loading
b) with transpallets loading

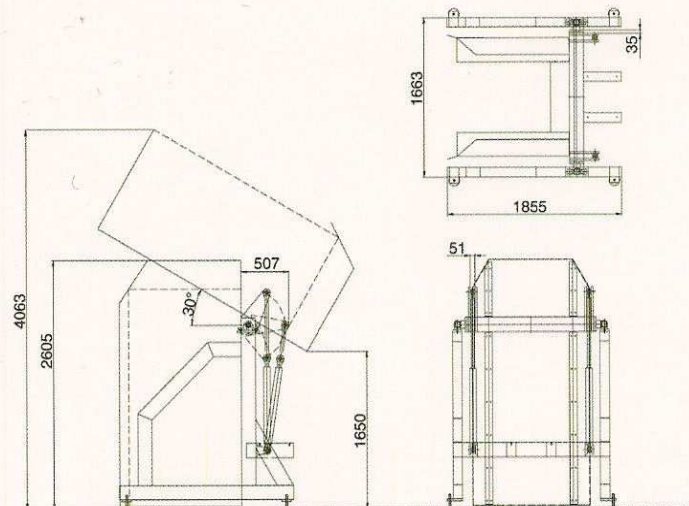

15 anni di lavoro fanno della Tecnopak un concentrato di esperienza e specializzazione nel settore della meccanica che permette di proporre una vasta gamma di prodotti per la movimentazione oltre a macchine per il confezionamento e dispositivi speciali.

Il ns. ufficio tecnico, in continua ricerca di innovazioni tecnologiche, è in grado di sviluppare progetti e proporre soluzioni concrete corredate da layout. Ai clienti viene offerto un servizio globale che va dal progetto al collaudo finale, seguendo il cliente anche nel corso degli anni grazie al servizio post-vendita.

FISHMAC S.R.L.

15 years of work have made Tecnopak a concentrate of experience and specialization on mechanic sector that permits to propose a wide range of products for movement, in addition to packaging machines and special devices. Our technical office, continuously researching technological innovations, is suitable to develop projects and to propose concrete solutions with layouts. A global service, from project to final test, is offered to customer that will be assisted during the passing of the years by our after sale department.



ILLUSTRAZIONI ED INFORMAZIONI SONO MOSTRATE A TITOLO PURAMENTE INDICATIVO. TUTTI I DIRITTI RISERVATI.
PICTURES AND INFORMATION ARE INDICATIVE ONLY. ALL RIGHTS RESERVED

FISHMAC s.r.l
Fish, food and packaging machines
Via Don Milani 40
43012 Fontanello loc. Sanguinaro (PR)
tel.0039 521 825538 - fax 0039 521 826279
email : info@fishmac.it

www.fishmac.it